

INSTALLATION MANUAL

| Version 1.1 |



Table of Contents

03 | 1. Product Image View

04 | 2. Caution for Safety

2.1. General

2.2. Installation and maintenance

05 | 3. Installation Environment

3.1. Recommended PC specifications

06 | 4. Components

4.1. Required tools

4.2. Laser indicator product briefing

4.3. Calibration Board briefing

10 | 5. Hardware Installation

5.1. Check the Ceiling level

5.2. Ceiling Bracket installation

5.3. Launch Monitor installation

5.4. Connection

Product Image View

Bottom View

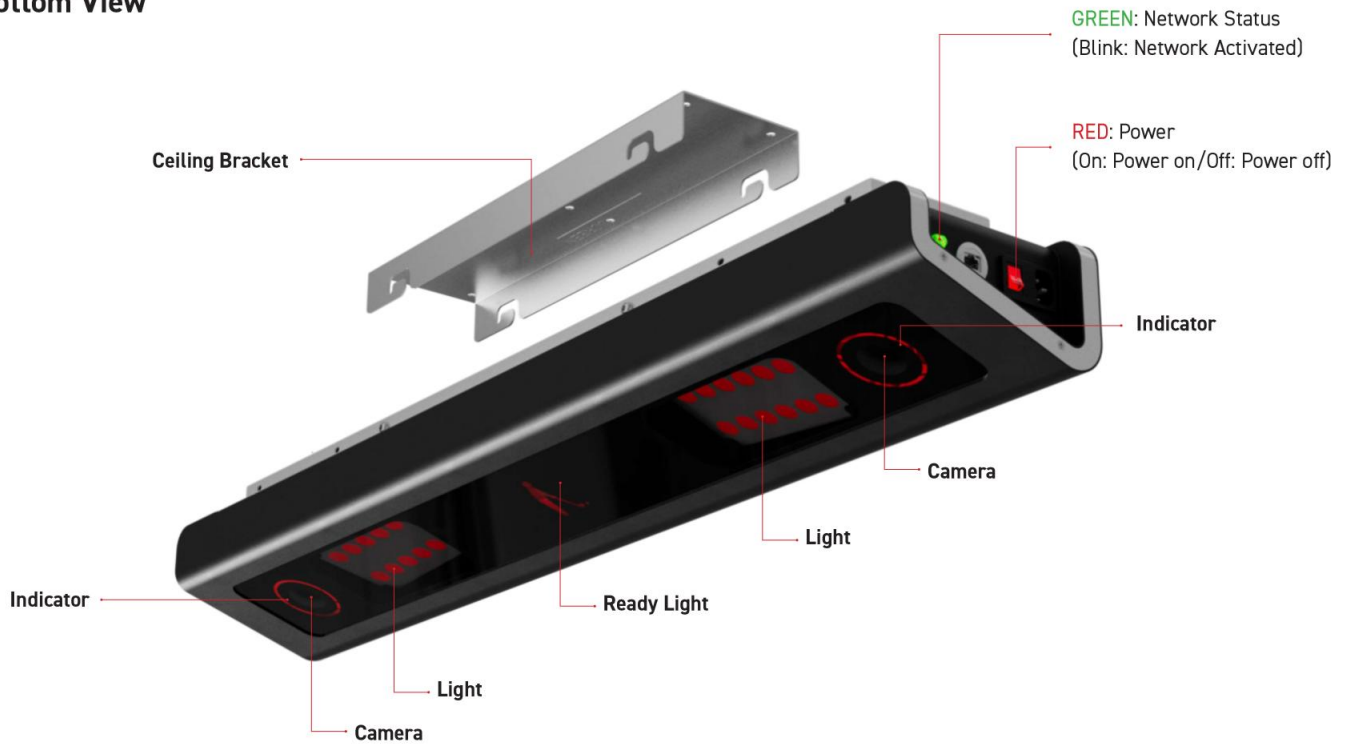

Top View

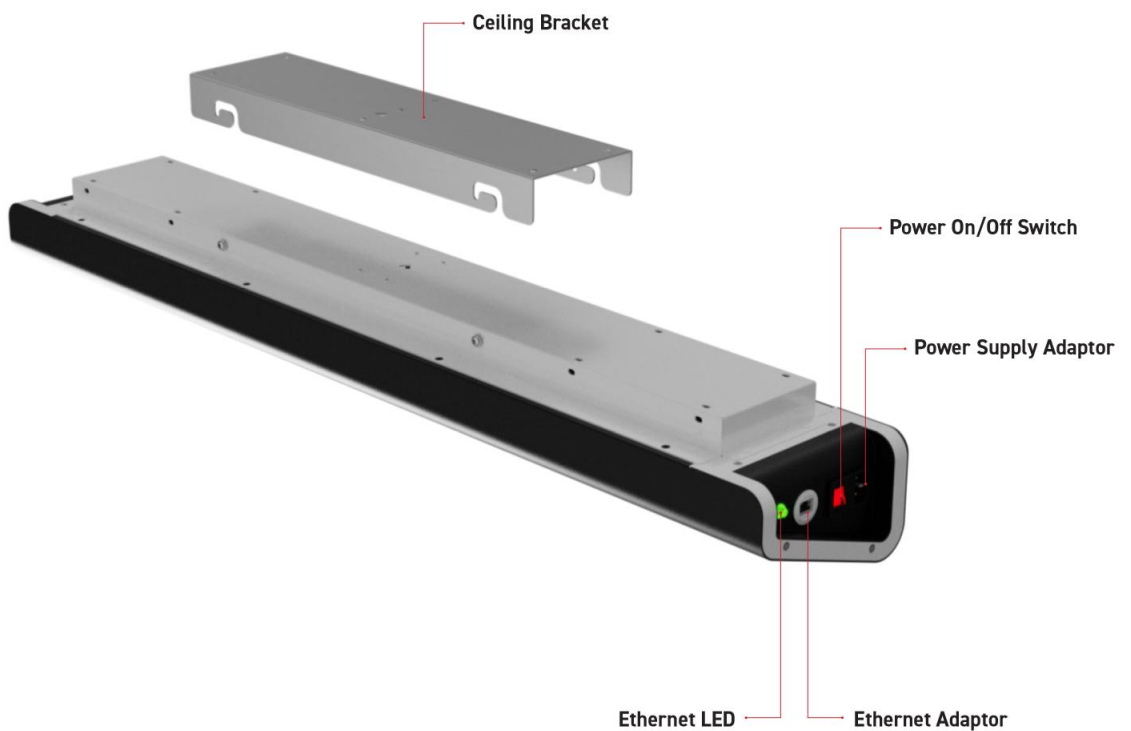

2. Caution for Safety

2.1. General



CAUTION

- Do not drop, disassemble, attempt to repair, or make any alterations to the device. These actions can cause serious damage to the Launch Monitor's electronics and could also result in an electric shock, which could harm both the device and the user.
- Do not let children touch the device without supervision.
- Stop If liquid, such as water, drinks, or chemicals, enters the device, stop using it immediately and contact the nearest dealer or manufacturer for technical assistance.
- Do not touch the device with wet hands. Doing so may cause an electric shock.
- Make sure that the temperature of the camera does not exceed 0°C to 40°C or 32°F to 104°F. Otherwise, the device may be damaged by extreme temperatures.

2.2. Installation and maintenance



CAUTION

- Do not install in dusty or dirty areas - or near an air conditioner or heater to reduce the risk of damage to the device.
- Avoid installing and operating in an extreme environment where vibration, heat, humidity, dust, strong magnetic fields, explosive/corrosive mists or gases are present.
- Do not apply excessive vibration and shock to the device. This may damage the device.
- Do not use solvents or thinners to clean the surface of the device. This can damage the surface finish.
- Do not put heavy objects on, or hang from, the product. If the product collapses or is dropped, you may be injured.
- Do not install this product on a wall if it could be exposed to oil or oil mist. This may damage the product and cause it to fall.
- Safely install the product in a place that can hold the weight of the product. A lack of strength may cause the product to fall.

3. Installation Environment

1. Distance from the Tee to the Screen is recommended to be at least 3000mm.
2. Distance from the Ground to the bottom of the Sensor is recommended to be between 2600mm and 3000mm.
3. Make sure the ceiling is level.

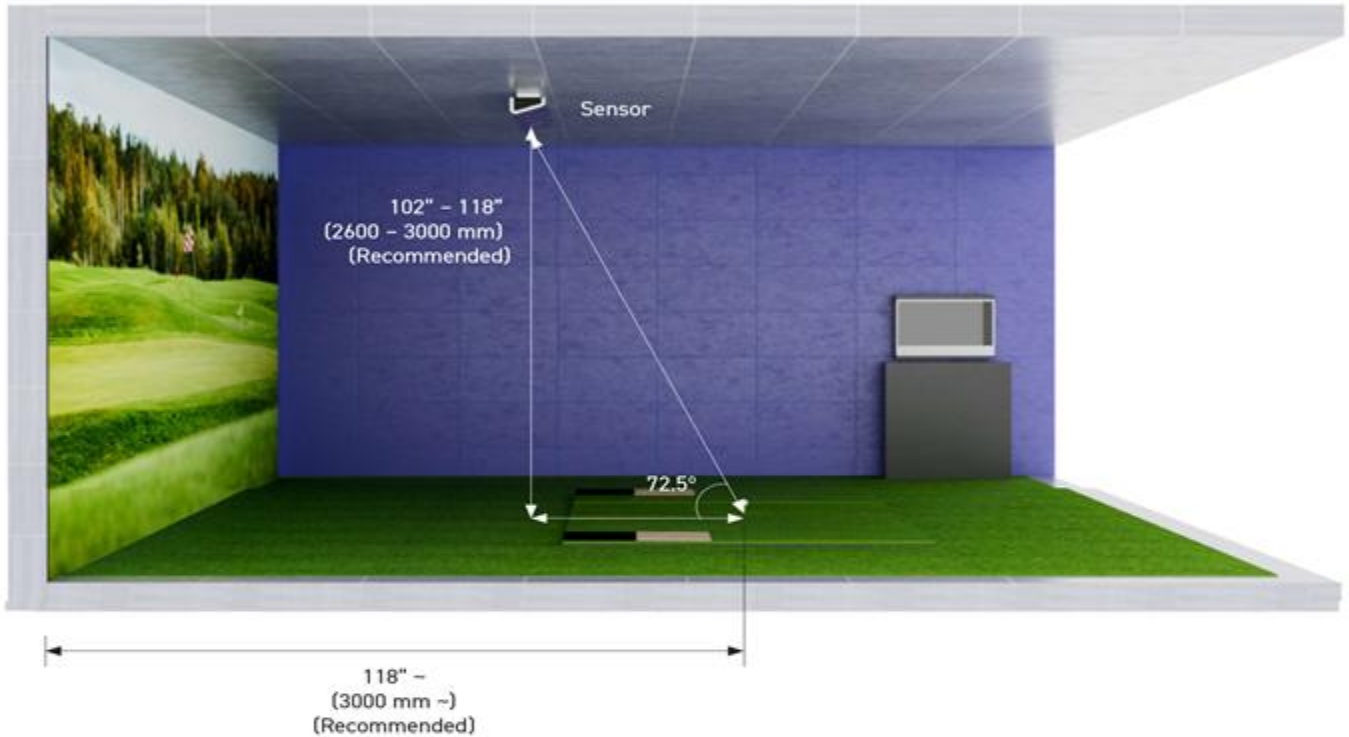

3.1. Recommended PC specifications

If the performance of the PC or NIC does not meet the recommended specifications, the performance of the camera may be affected.

Operating System	Windows 10 (x64)
CPU	Dual Core 3.0GHz or higher (Over then Intel Core i5 or AMD Ryzen 3 recommended)
RAM	16GB or higher
HDD Free Space	10GB or higher
Gigabit Ethernet Interface	<p>for Chipset</p> <ul style="list-style-type: none"> • Intel Pro/1000 class Chipset recommended • A NIC that supports Jumbo Packet recommended • NIC with 2048 or higher Receive Descriptors recommended <p>for NIC Card</p> <ul style="list-style-type: none"> • Recommended NIC Card: EXPI9301CT (1Ch Intel NIC Card)

Additional Notes for Laptop Environments

Some laptop-integrated Ethernet controllers and OEM network drivers may not expose advanced NIC tuning options such as Receive Descriptors / Buffer settings.

For stable GigE streaming performance, desktop-class Ethernet environments are recommended.

4. Components

The following items are included with the Launch Monitor. Make sure they are all present and accounted for.

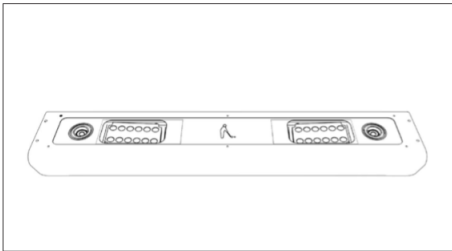

Launch Monitor (x1)

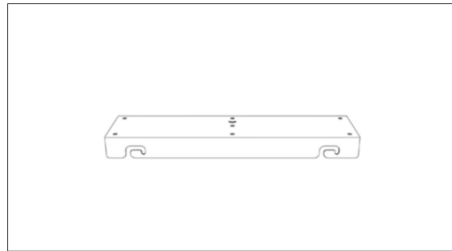

Ceiling Bracket (x1)

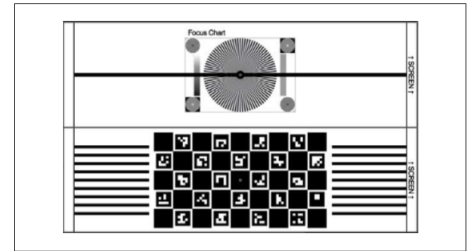

Calibration Board (x1)

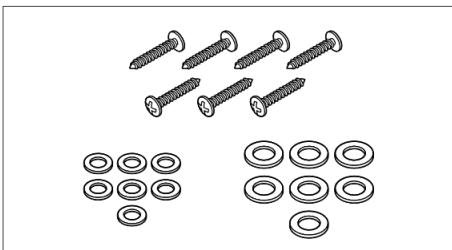

Ceiling Bracket Screw (x7)



Power Supply Cable (x1)

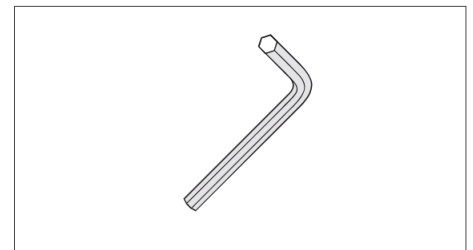

L-Wrench (x2)



Marked Ball (x20)

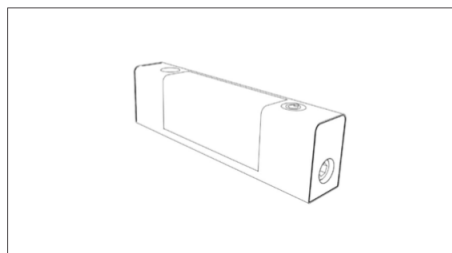

Laser Indicator (x1)

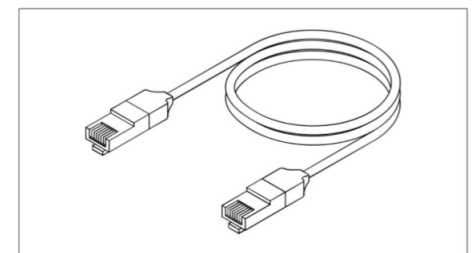

CAT6 Ethernet Cable (x1)

4.1. Required tools

The following items are needed for the Launch Monitor installation. (not included in the package)

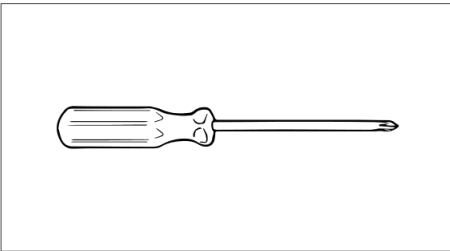

Cross-head Screwdriver

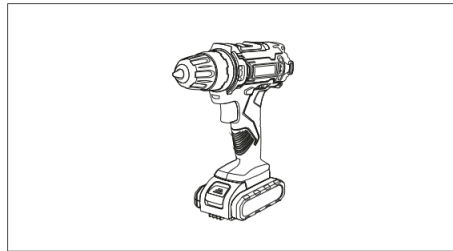

Electric Drill

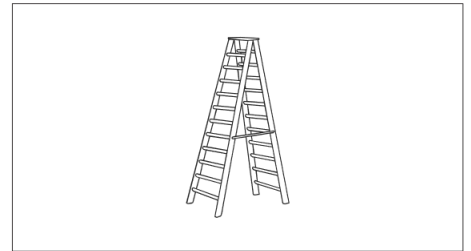

Ladder

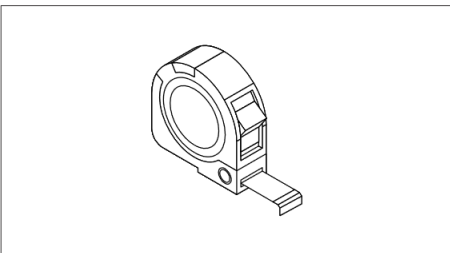

Tape measure

4.2. Laser indicator product briefing

Power Button

1. Startup & Shutdown

- Startup: Short press the power button on the right side for about 1 second to power on.
- Shutdown: Long press the power button on the right side for about 2 seconds to turn off the power.
No operation within 180 seconds will automatically shut down.

2. Laser On / Off

- Laser on: Short press on the right button when switched on to project a crossed red laser.
- Laser off: Short press on the right button again to turn off the laser line.

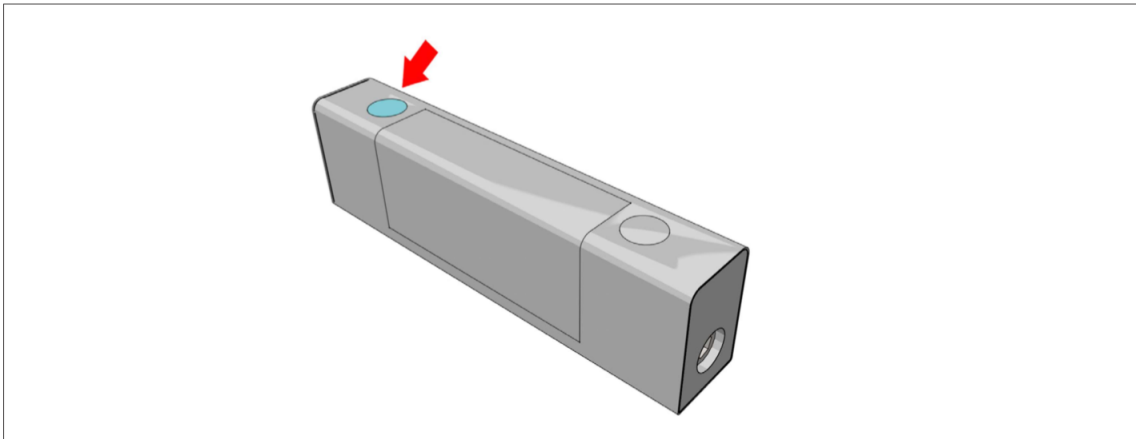

4.3. Calibration Board briefing

Note Components for the Calibration Board that are used for the Calibration process.

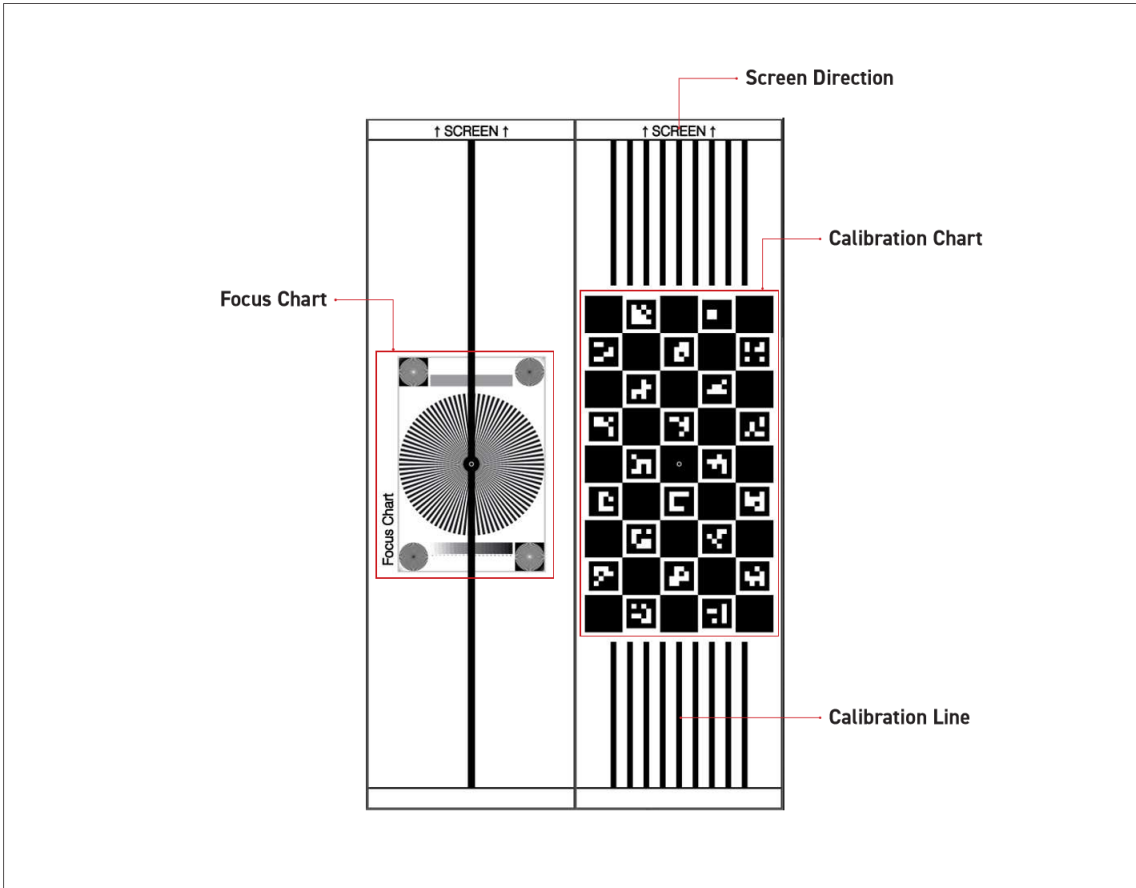

5. Hardware Installation

Note Make sure the distance from the Ground to the Ceiling is between 2700mm and 3100mm and the Ceiling is level before proceeding with the installation.

5.1. Check the Ceiling level

With Laser Indicator

1. Position the Laser Indicator in both directions and check the angle.

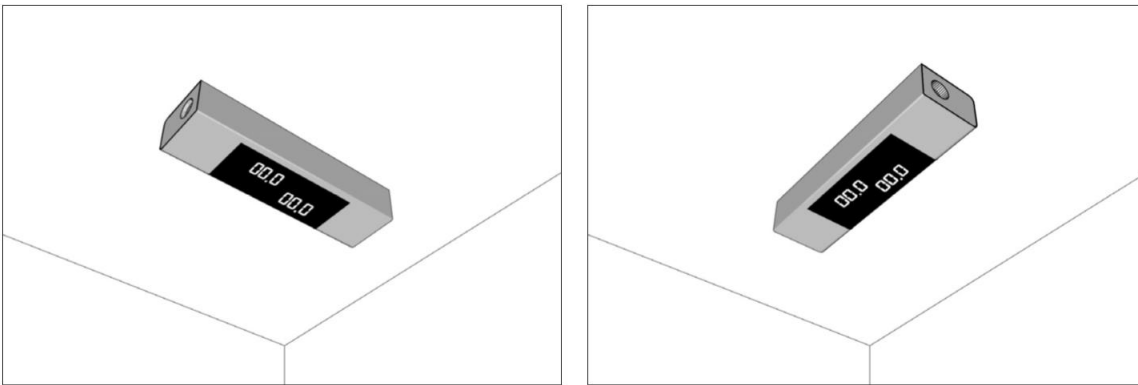

5.2. Ceiling Bracket installation

1. Measure the distance(H) from the floor to the ceiling.

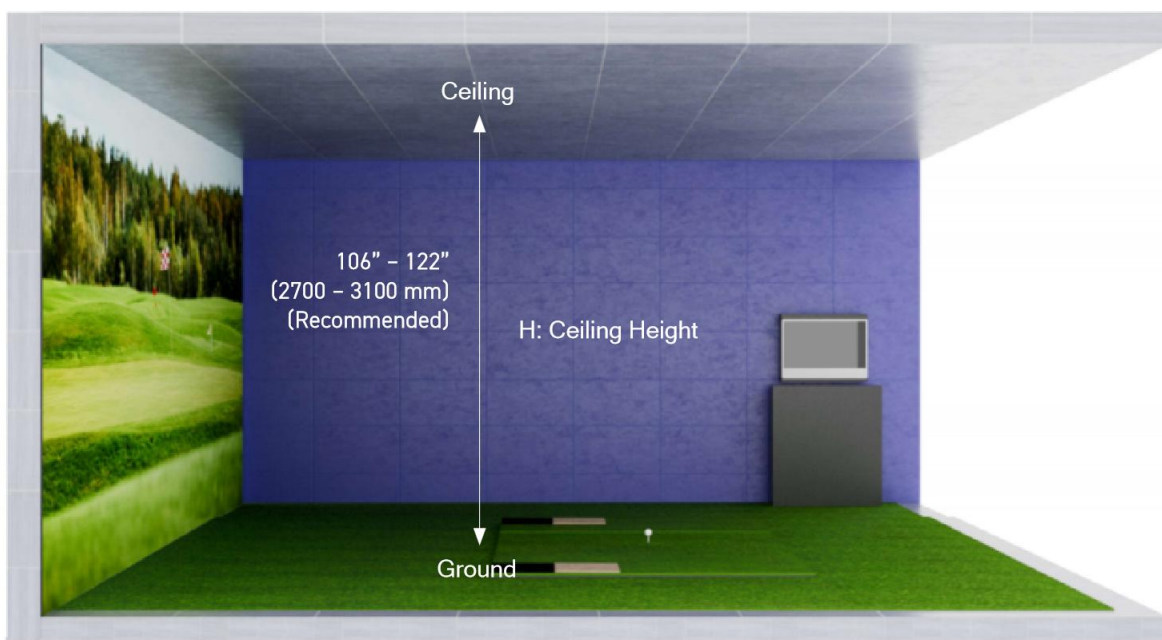

2. Find the center of the hitting area.



3. Draw a vertical line perpendicular to the screen.



4. Mark at a distance of Lmm away from the previous mark in the direction of the screen.

Please refer to the table below for the distance according to ceiling height.

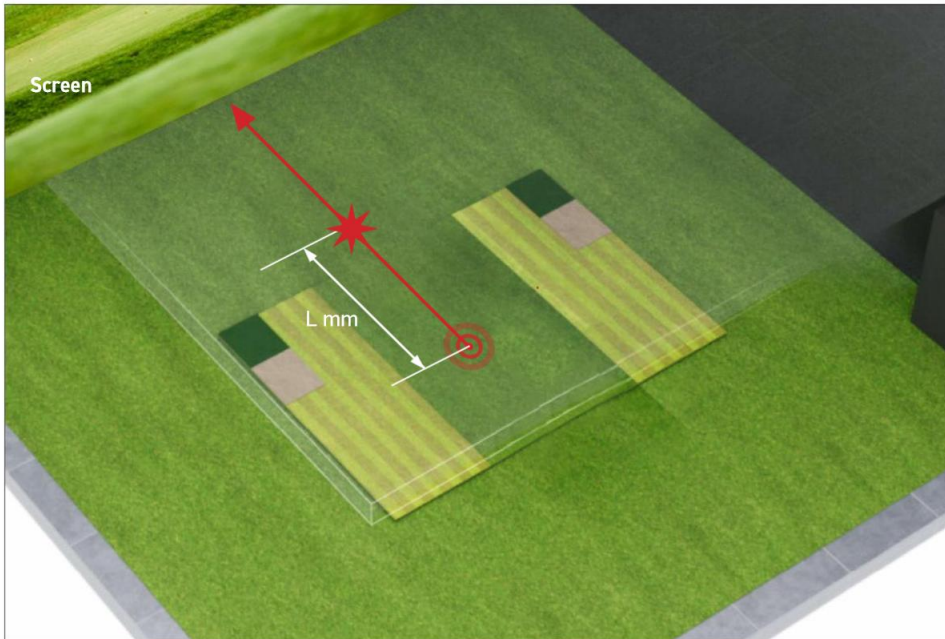

H(mm)	2700	2750	2800	2850	2900	2950	3000	3050	3100
L(mm)	820	836	851	867	883	899	914	930	946

5. Draw a mark on the ceiling perpendicular to the mark on the floor.

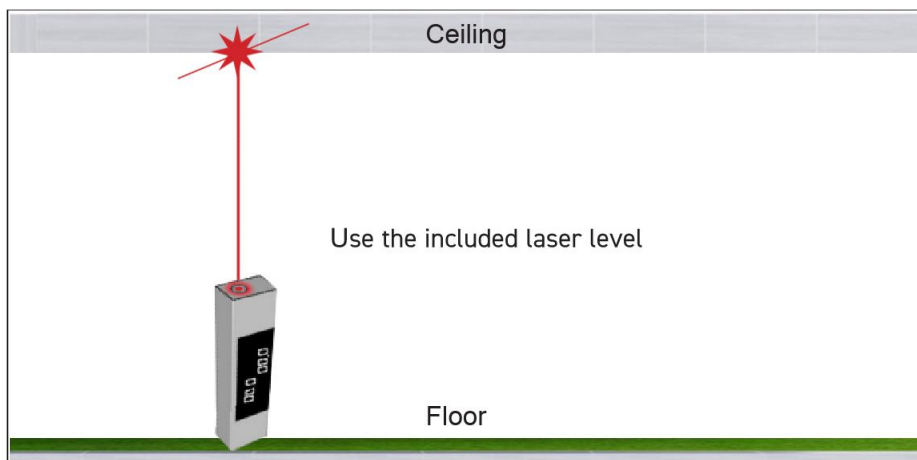

6. Drive the screw into the center of the bracket.

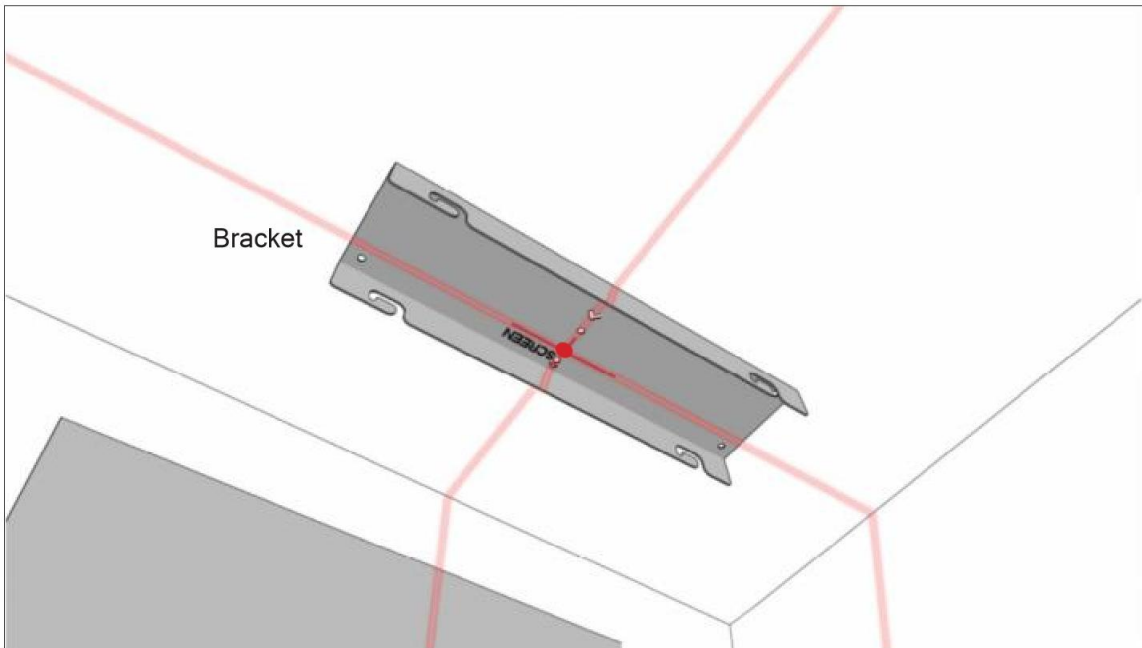

7. Fix the ceiling bracket with screws (7ea) on the ceiling.

- Please refer to step 7-1 and 7-2 on the next page
- Check if the ceiling is level
- Take care to keep it parallel with the screen

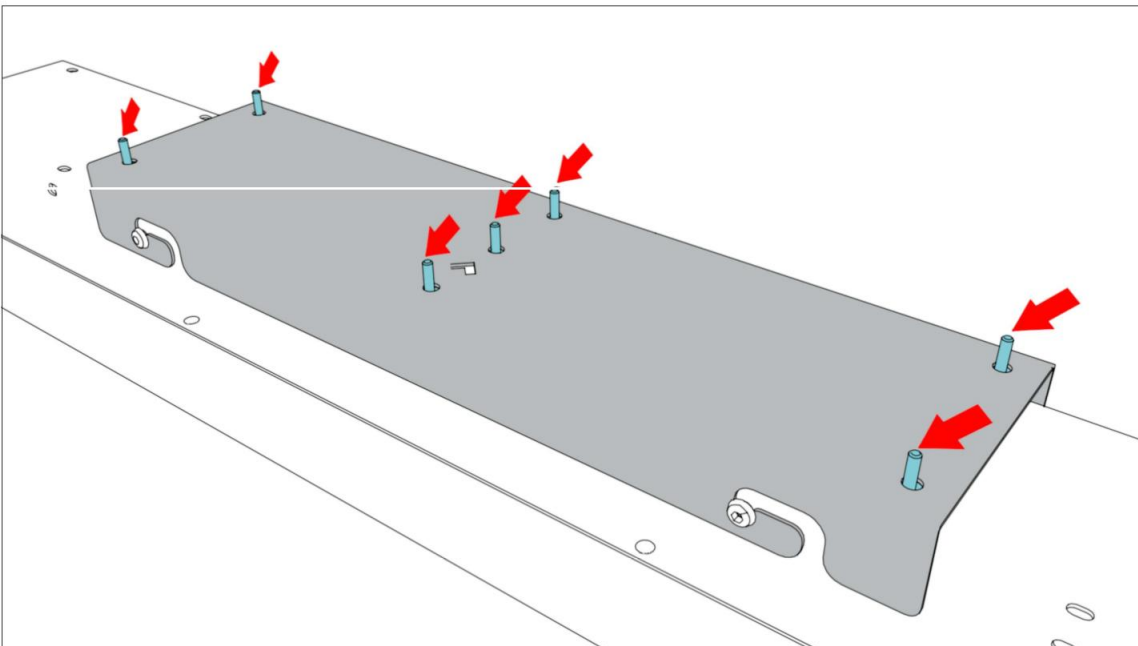

7-1 Check the launch monitor alignment using calibration program.

It is a good idea to temporarily install a launch monitor to check and align before fully tightening.
To do this, you must connect the power and LAN cables, set up the network, and run the calibration program.

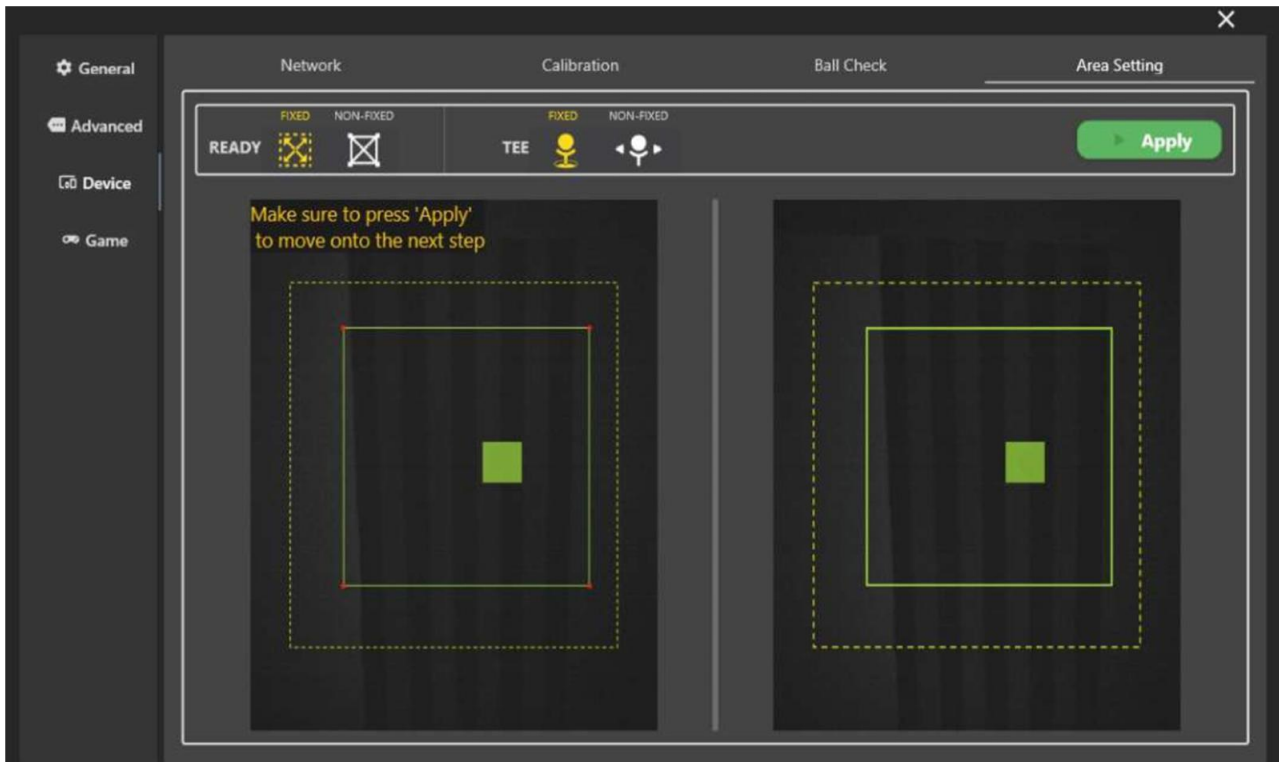

5.3. Launch Monitor installation

Note If you have finished fixing the Ceiling Bracket, you can install the Launch Monitor.

1. Place the Sensor so that the arrow direction faces the Screen.

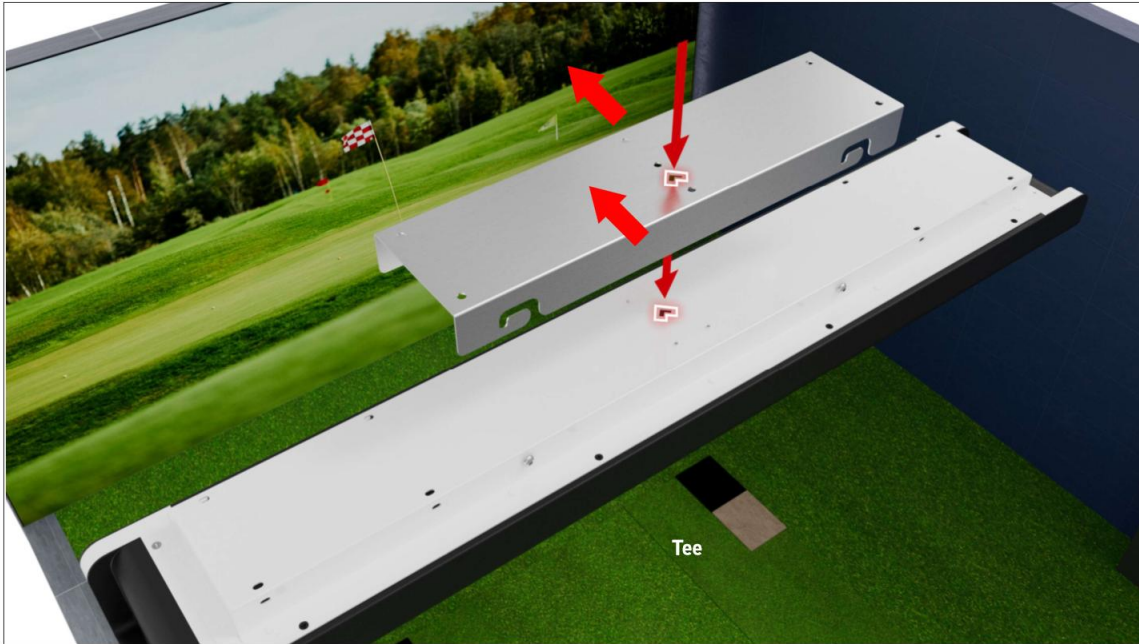

2. The Launch Monitor comes with 4 screws already inserted. Make sure all 4 screws are half-loosen.
3. Hang the Launch Monitor on the Ceiling Bracket with the 4 screws.

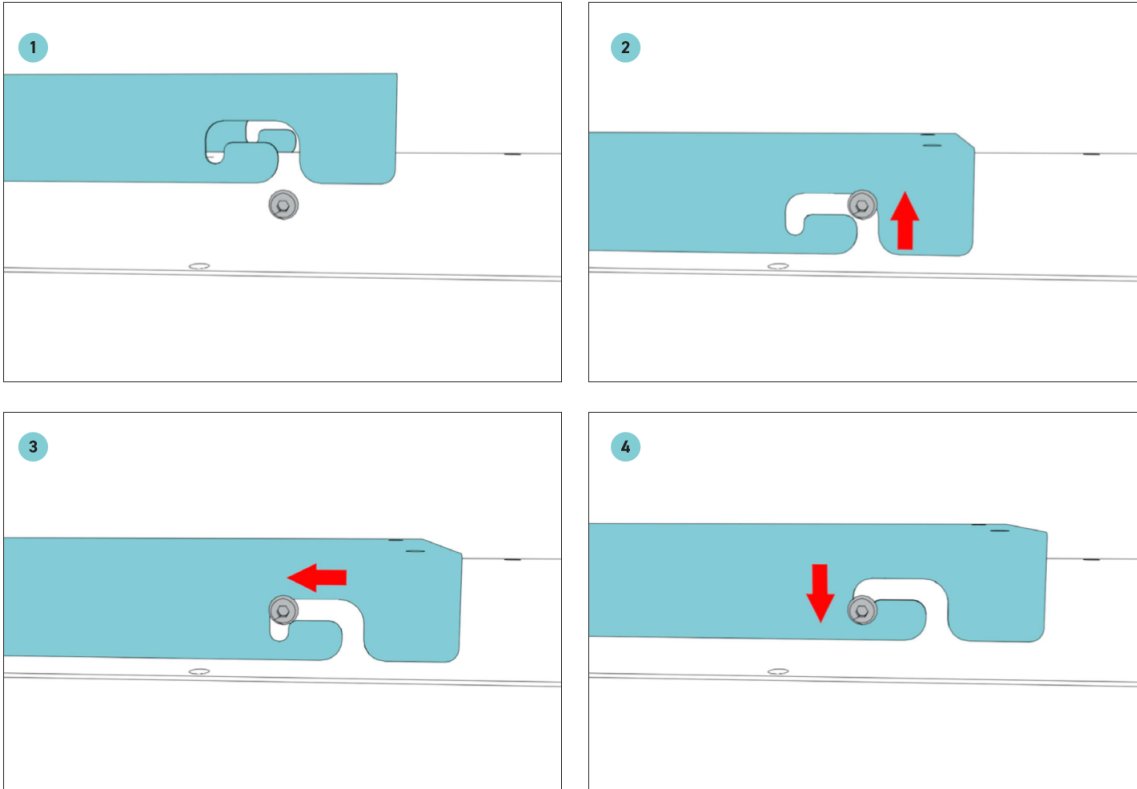

4. Press down so that the Bracket and Sensor are in close contact.
5. Tighten the 4 screws to the Launch Monitor.

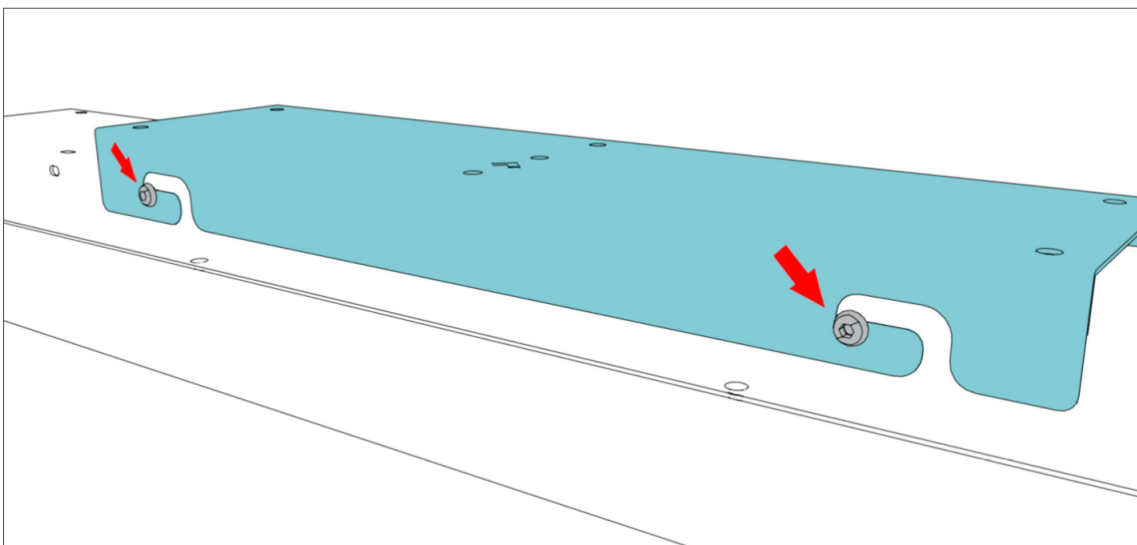

5.4. Connection

Note The plug must be plugged into a matching outlet that is properly installed and grounded in accordance with all local codes and ordinances.

1. Connect Power Cable to the Power Supply Adaptor.

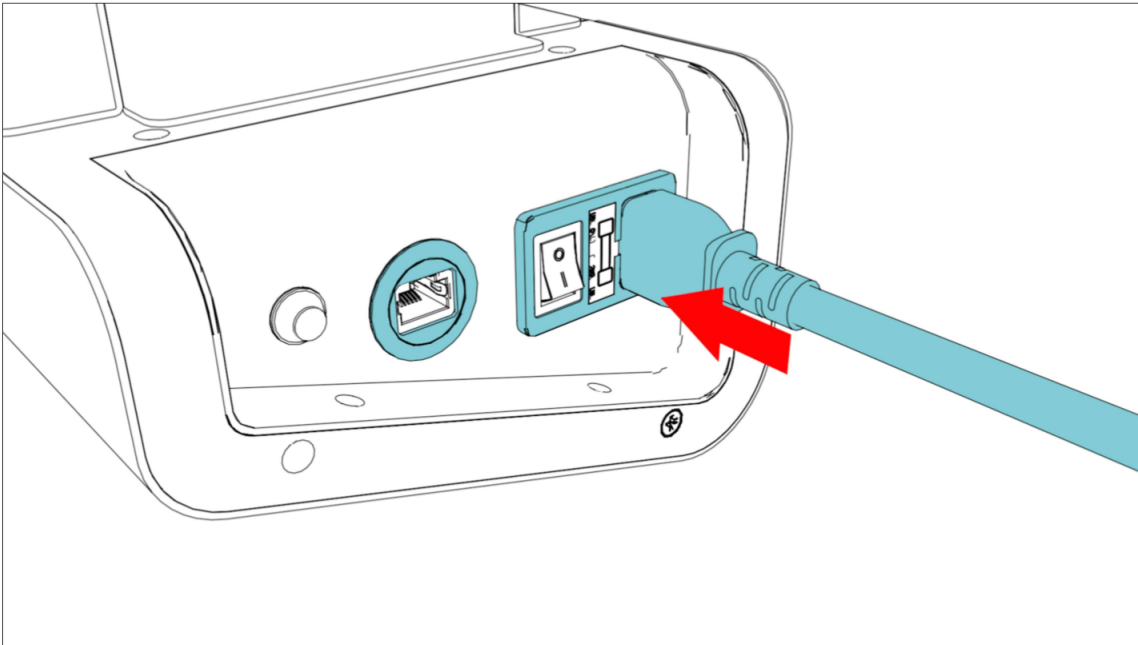

2. Connect the Ethernet Cable to the Sensor and the PC directly.

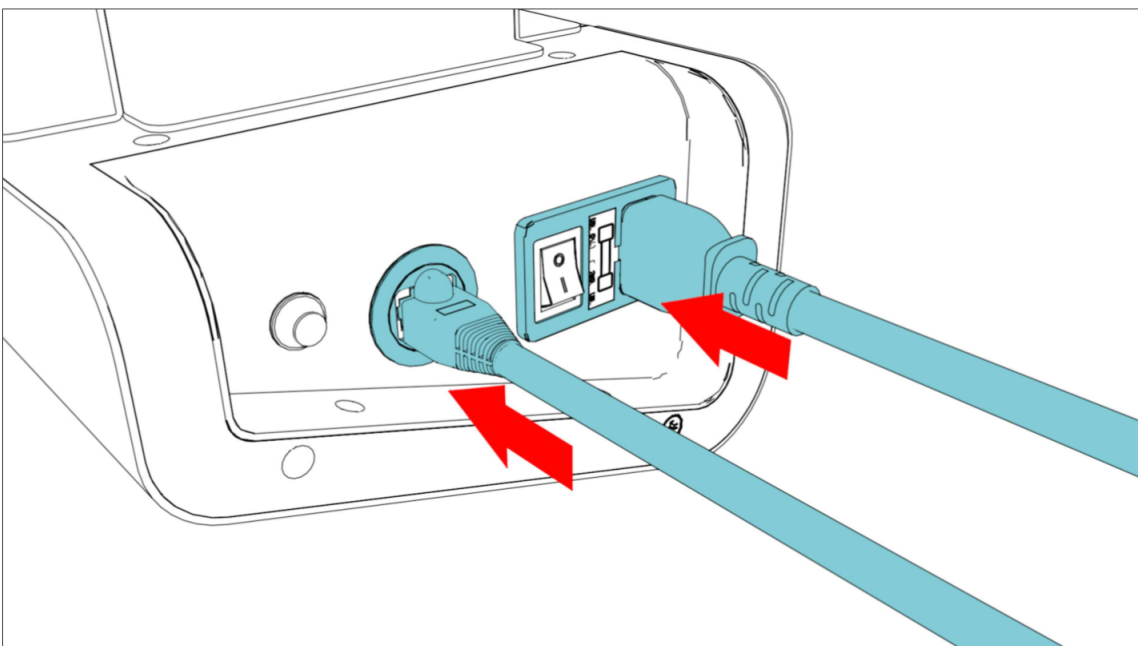

3. Turn on the Launch Monitor power switch. If the power is on, you can see the red light is bright (Power Switch) and the green light blinking (Ethernet LED).

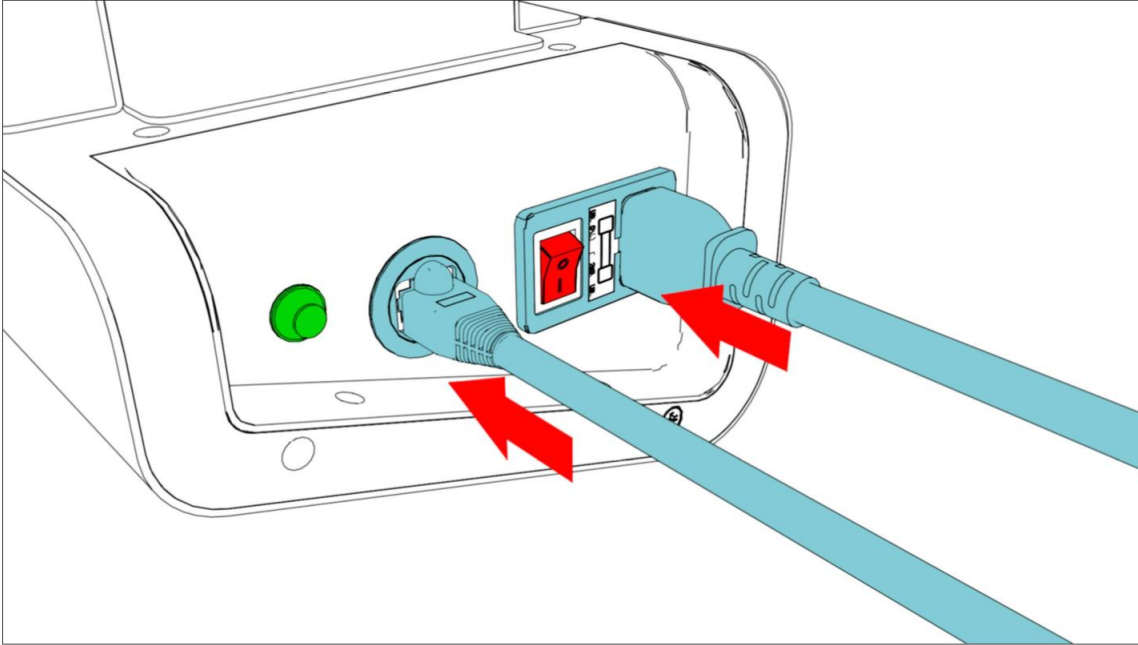

4. Check the Indicator Status.

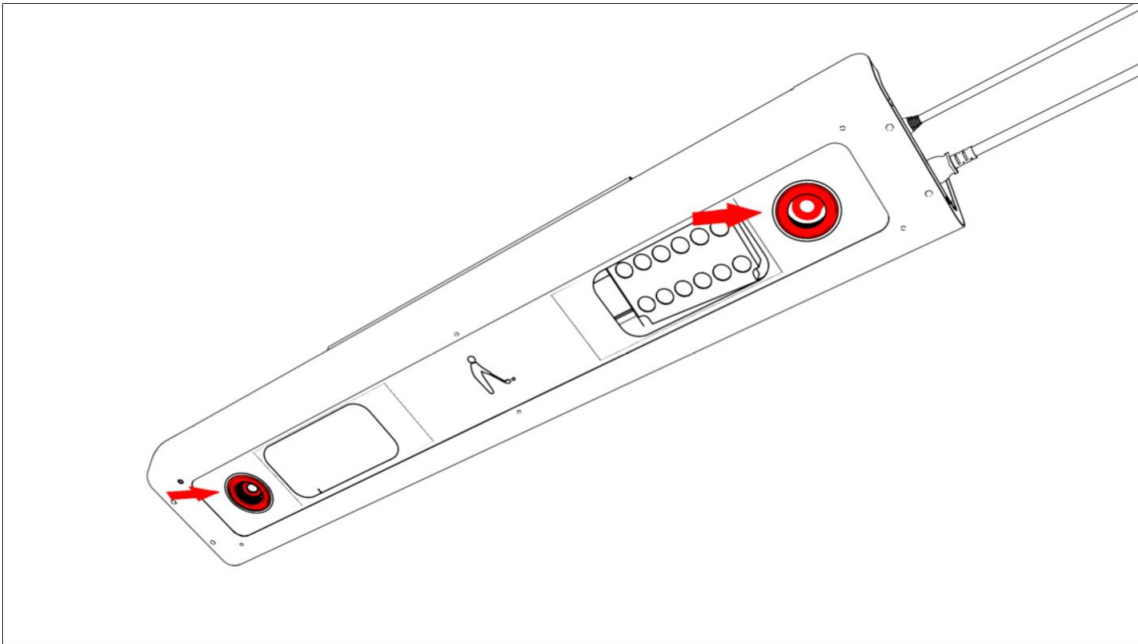



INSTALLATION MANUAL

